

CHIAYO

CHALLENGER

Modulized Wireless Portable Amplifier System

Operation manual



ISO 14001



OHSAS 18001



GREEN PRODUCT



IF DESIGN AWARD



HKEIA AWARD



TAWAN
EXCELLENCE



TAWAN GOOD
DESIGN





IC: 3563A-CHALLENGER
IC: 3563A-SQ5016
IC: 3563A-SM5016

Please read and follow the instructions in this manual thoroughly to obtain optimum results from this unit. We also recommend that you keep this manual handy for future reference.

Safety Precautions

- Be sure to read the instructions in this section carefully before use.
- Make sure to observe the instructions in this manual as the conventions of safety symbols and messages regarded as very important precautions are included.

Safety symbols and messages described below are used in this manual to prevent bodily injury and property damage which could result from mishandling. Before operating your product, read this manual first and understand the safety symbols and messages so you are thoroughly aware of the potential safety hazards.

 WARNING	Indicates a potentially hazardous situation which, if mishandled, could result in death or serious personal injury.
 CAUTION	Indicates a potentially hazardous situation which, if mishandled, could result in moderate or minor personal injury, and/or property damage.

Make sure to observe the following handling precautions so that a fire or personal injury does not result from leakage or explosion of the battery.

- Do not short, disassemble, heat or put the battery into a fire.
- Never charge batteries of the type which are not rechargeable.
- Do not solder a battery directly.
- Be sure to use the specified type of battery.
- Note the correct polarity when inserting a battery in the unit.
- Avoid locations exposed to the direct sunlight, high temperature and high humidity when storing batteries.

 WARNING	To prevent the electromagnetic wave from badly influencing medical equipment, make sure to switch off the unit's power when placing it in close proximity to the medical equipment.
---	---

 CAUTION	Battery discharge naturally according to a certain pattern even not in use. For best performance and a prolonged lifespan, battery should be charged regularly after every use or every month when the system is in storage and not being used! CD player optical pick up head is a very delicate device and sensitive to humidity. Please avoid using it in high humidity area to avoid damage! .
---	--

CHALLENGER 1000 (Master)

A,B&D. Slot for receiver/MP3/Bluetooth module

C. Slot for receiver/transmitter/MP3/Bluetooth module

E&F. Slot for other modules (CD player, DVD player, MP3+Bluetooth player...)

1. Wired microphone volume control
2. Line-in volume control
3. Tape/DVD power+volume control
4. Tone volume control (BASS)
5. Tone volume control (TREBLE)
6. Master volume control
7. Wired microphone input
8. Line input/output
9. Voice priority
10. Slave output
11. Battery low indicator (RED)
12. Charging indicator
13. Fuse
14. 24~32V DC input
15. AC input
16. Power switch
17. Speaker out

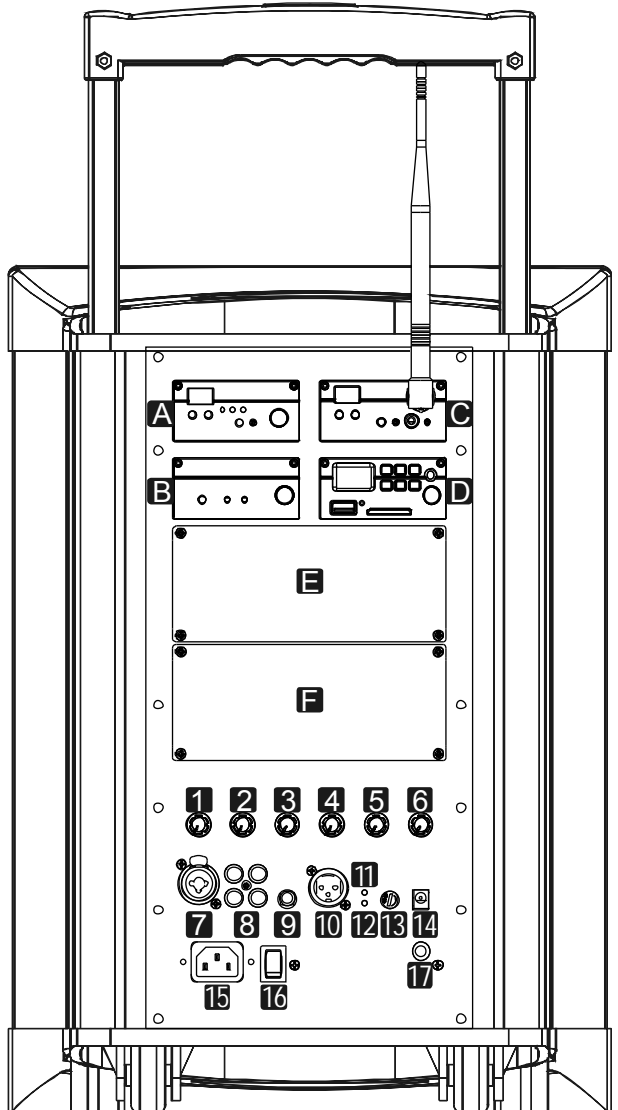

CHALLENGER Companion powered speaker

- A. Slot for receiver/MP3/Bluetooth module
- B. Slot for receiver/transmitter/MP3/Bluetooth module
- 1. Audio link input
- 2. Audio link output
- 3. Volume control
- 4. Speaker out (switched)
- 5. Speaker out (unswitched)
- 6. 24~32V DC input
- 7. Fuse
- 8. Power status indicator (RED)
- 9. Power status indicator (GREEN)
- 10. Charging indicator
- 11. AC input
- 12. Power switch

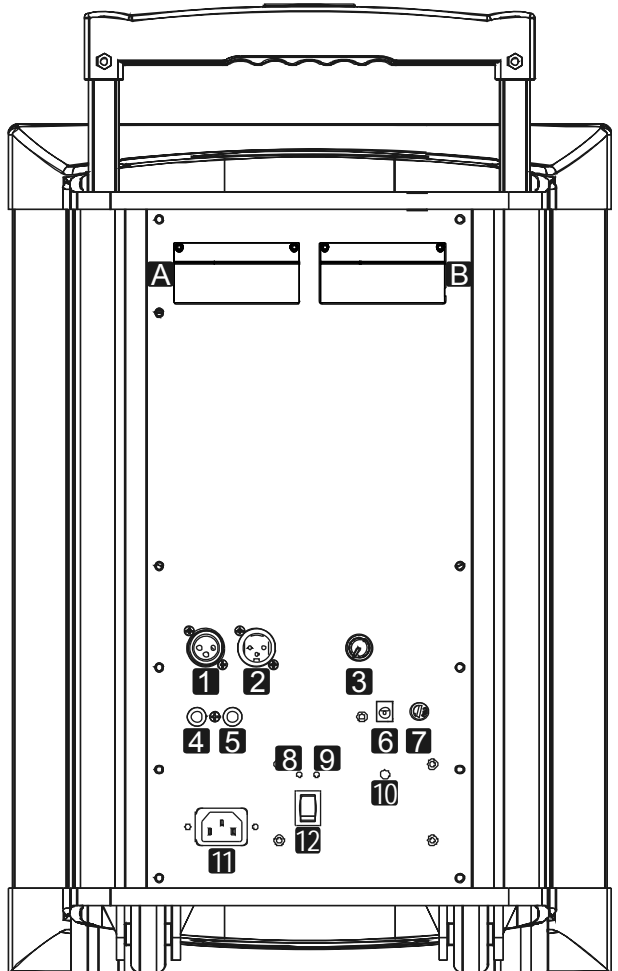

CHALLENGER Companion passive speaker

1. Speaker input
2. Speaker output

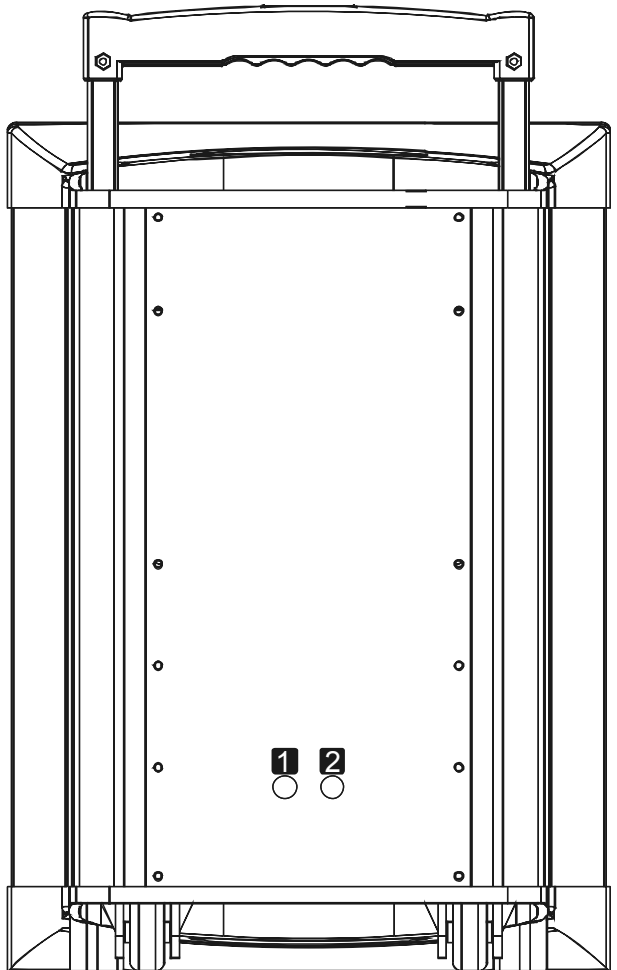

Operating procedures

After unpacking the unit for the first time, please charge the unit for at least 6 hours before operation. This is absolutely necessary as the built-in rechargeable batteries might have been discharged naturally due to long shipment and storage time, even though it has been fully charged in the factory prior to shipment.

To operate this portable sound unit, switch on the main POWER switch. If the Battery low indicator also glows, it means the batteries are weak and please recharge them.

The main POWER switch does NOT switch on the other devices as each of them has individual Power/Volume control. To operate each of them, you must switch them on accordingly.

Operating the dynamic wired microphone

To use a cable microphone, simply plug it into the MIC IN socket. The mic socket accepts both phone and Cannon jack. Rotate the dedicated volume control knob and master volume control, amplified sound could be heard from the speaker when voice is spoken into the cable microphone.

Operating the wireless microphone system

To operate the wireless system, just switch on the power/volume control on the module panel and the matching transmitter. Please set the same channel on both the transmitter and receiver before operation. Please as well make sure that master volume control is set to minimum level before turning the unit on, especially working on a wireless version! Set the Master volume control to the mid position. Rotate the volume control knob on receiver panel clockwise to the desired levels. When voice is spoken into the transmitter, amplified sound should be heard over the built-in speaker.

Voice Priority (Ducking) operation

Voice Priority operation is only necessary when CD or other acoustic device is playing. If the Voice Priority switch is put to ON position, the ducking function will be activated. While the music is playing, a voice input from either a wired or wireless microphone will temporarily override and turn down the volume of the background music and voice could be heard clearly. Background music will return to its original setting when no audio input is entering the microphone for a certain time. However, if the microphone is not switched off, the music entering the microphone will also activate the voice priority function. So, Voice priority is best operated using microphones with on/off switch.

Battery Charging

Internally, the CHALLENGER 1000 contains two 12V/5AH maintenance free lead acid batteries, which have no memory effect.

When the batteries are weak, the battery low indicator LED will stay RED. To charge the batteries, simply plug in the AC power supply, the charging process will start automatically.

While charging, the charging indicator will flash GREEN. When batteries are fully charged, the charging indicator will stay GREEN.

Wired Audio Link

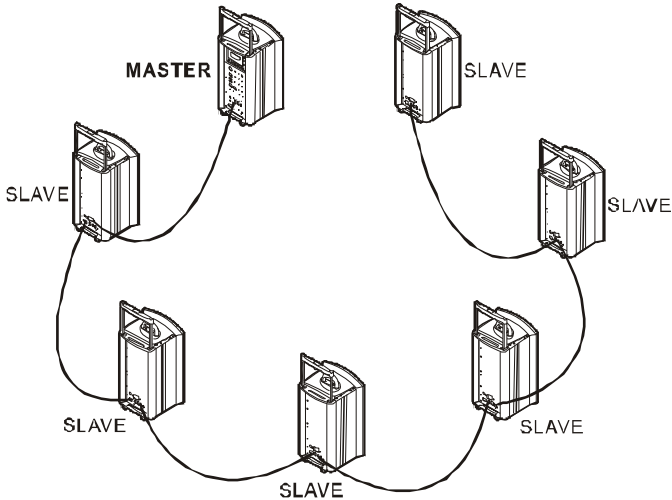

The CHALLENGER 1000 could be operated as MASTER as well as SLAVE. This depends on the setting of Master/Slave selector switch. However, the CHALLENGER Slave can only be operated as SLAVE.

In order to operate Audio Link, you must have a CHALLENGER 1000 unit that operates as a MASTER. Only one unit is allowed to act as MASTER and the other(s) MUST operate as SLAVE(s). A MASTER unit is capable of connecting up to about 20 SLAVE units.

For the MASTER unit, the MASTER/SLAVE selector switch must be set to MASTER mode. The CHALLENGER SLAVE unit does not have this selector. If you have two units of CHALLENGER 1000, you could use one as Master and the other CHALLENGER 1000 as slave. To do that, just put the MASTER/SLAVE selector switch of the second CHALLENGER 1000 to SLAVE mode. For the MASTER unit, Audio Link IN jack should NOT be connected.

To operate Audio Link, connect the Output jack of the MASTER to the Audio Link IN jack of the 1st SLAVE unit. The Output jack of this SLAVE should be connected to the Input jack of the 2nd SLAVE unit. Similar connection shall continue as such for the following SLAVE units.

Volume Control for MASTER or SLAVE

When used on the MASTER, it controls the MASTER as well as all the SLAVE units. When used on the SLAVE unit, it only controls that particular SLAVE unit volume. Maximum number of SLAVE units to be connected with a MASTER is about 20.

Remark: There should NOT be a connection between the last SLAVE unit output and the input of the MASTER unit.

Wireless Audio Link

Different from Wired Audio Link, with new SLAVE's capability of installation of receiver and transmitter modules it eliminates all cable connection and largely extends the number limit of SLAVEs.

Application: For crowds of 1000 to 2000. (e.g., speeches or forums)

Configuration: One Master + several SLAVEs (with receiver module built in)

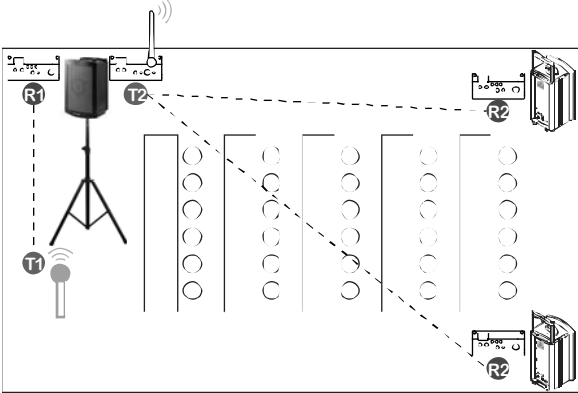

Application: For crowds of over 3000. (e.g., stadiums)

Configuration: One Master + several SLAVEs (with receiver and transmitter module built in)

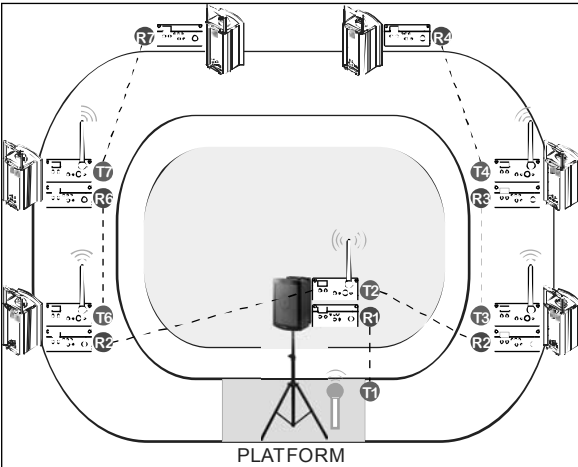

T: Transmitter R: Receiver **Module number: 1,2,3,...**

T1 goes to R1, T2 goes to R2, T3 goes to R3, T4...

SDR-5200M IrDA | SDR-5100M IrDA | SDR-5116M receiver modules

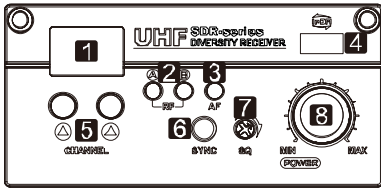

- 1. Channel indicator
- 2. Diversity A/B indicator
- 3. Audio signal indicator
- 4. IR sensor area (IrDA series only)
- 5. Channel Select/Scan buttons
- 6. IrDA synchronizing button (IrDA series only)
- 7. Squelch control
- 8. Power switch/volume control

Verify channel and frequency in use

The channel LED ① will show last stored frequency and channel. For example, if channel 36 is 608.750MHz, the LED will first display 60,87,50 and 36 in sequence.

Frequency: **60** ▶ **87** ▶ **50** ▶ *Channel:* **36**

Select a channel that corresponds to the transmitter. When transmitter is turned on, either A or B diversity indicator ② will light up to indicate that it is connected.

Changing channels

SDR-5200/5100M IrDA (100 channels)

Press LEFT button to increase the TENS-digit channel number.

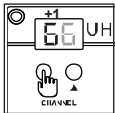

Press RIGHT button to increase the UNIT-digit channel number.

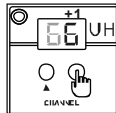

SDR-5116M (16 channels)

Press LEFT button to increase the channel number.

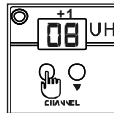

Press RIGHT button to decrease the channel number.

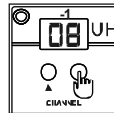

CHANNEL scanning (IrDA series only)

For an interference-free operation, a cleaner channel might be necessary if the current one receives too much interference. Before scanning, the transmitter must be switched off.

1. Press and hold either channel button for 3 seconds
2. The receiver will find and locate a clear, interference-free channel.

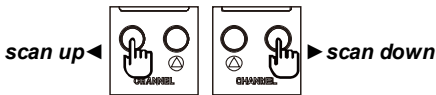

36 ▶ **42**

SQUELCH (SQ) setting

When interference is encountered try reducing the sensitivity of the receiver by turning the SQ control clockwise, thus less susceptible to interference. If this still does not solve the problem it means this frequency is not suitable. Adjust the squelch back to where it was and use the scan function to locate a clear, interference-free channel.

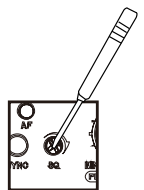

CHANNEL SYNCHRONIZING of the receiver and transmitter

Align infrared areas of the receiver and transmitter within 30cm.

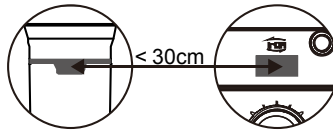

A. Changing the receiver's channel

1. Press the synchronizing button of the transmitter.

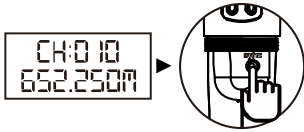

2. The transmitter's LED will glow to denote synchronizing signal transmitted.



3. The channel number on the receiver's LED will become the same as the transmitter's, which means the receiver has been successfully synchronized.



B. Changing the transmitter's channel

1. Press the SYNC button of the receiver.

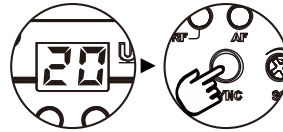

2. The transmitter's LED will glow to denote synchronizing signal received.



3. The channel number on the transmitter's LCD will become the same as the receiver's, which means the transmitter has been successfully synchronized.



SDR-8200M IrDA | SDR-8100M IrDA receiver modules

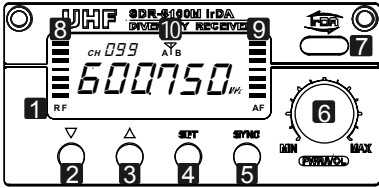

- 1. LCD
- 2. DOWN button
- 3. UP button
- 4. SET button
- 5. IrDA synchronizing button
- 6. Power switch/volume control
- 7. IR sensor area
- 8. RF signal meter
- 9. Audio signal meter
- 10. Diversity A/B antenna

First turn on the power ⑥ and the LCD display ① will show last stored channel and frequency. Select a channel that corresponds to the transmitter. When transmitter is turned on, the A/B diversity antenna ⑩ will appear to denote that it is connected.

Changing CHANNEL / FREQUENCY

- 1. Press ▲ (up) or ▼ (down) button to make the channel icon **CH** appear on the bottom.
- 2. Hold **SET** button until this icon **CH** flashes to denote readiness for setting.



- 3. Press ▲ (up) or ▼ (down) button to select a new channel. As the channel changes, the frequency changes accordingly, too.
- 4. After a channel is chosen, press **SET** button or wait 5 seconds to store the setting.



CHANNEL scanning

For an interference-free operation, a cleaner channel might be necessary if the current one receives too much interference. To operate the scanning:

- 1. Press ▲ (up) or ▼ (down) button to make the frequency icon **FREQ** appear on the bottom.
- 2. Hold **SET** button until this icon **FREQ** flashes to denote readiness for setting.

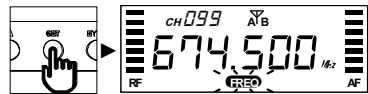

- 3. Press ▲ (up) or ▼ (down) button to find and locate a clear, interference-free channel.
- 4. After a channel is chosen, press **SET** button or wait 5 seconds to store the setting.

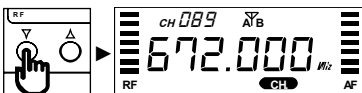

Channel synchronizing between receiver and transmitter

Align infrared areas of the receiver and transmitter within 30cm.

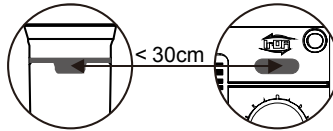

A. Changing the receiver's channel

1. Press the synchronizing button of the transmitter.

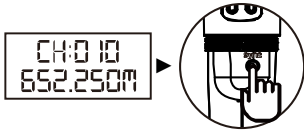

2. The transmitter's LED will glow to denote synchronizing signal transmitted.



3. The channel number on the receiver's LED will become the same as the transmitter's, which means the receiver has been successfully synchronized.

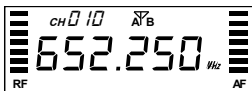

B. Changing the transmitter's channel

1. Press the SYNC button of the receiver.

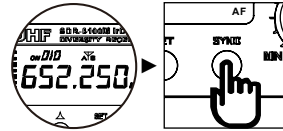

2. The transmitter's LED will glow to denote synchronizing signal received.



3. The channel number on the transmitter's LCD will become the same as the receiver's, which means the transmitter has been successfully synchronized.



If it doesn't work check that you have the IR sensor panels aligned, that they are facing each other, devices are within 30cm of each other, and try again.

SQUELCH (SQ) setting

When interference is encountered try reducing the sensitivity of the receiver, thus less susceptible to interference. To operate the squelch setting:

1. Press ▲(up) or ▼(down) button to turn to the squelch setting page.
2. Hold **SET** button until this icon  flashes to denote readiness for setting.

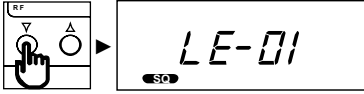

3. Press ▲(up) or ▼(down) button to select a new squelch level between 1 and 10.
4. After a level is chosen, press **SET** button or wait 5 seconds to store the setting.

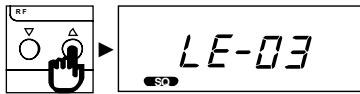

Since increasing the squelch level will also reduce the reception distance, it's recommended to choose the lowest level that can eliminate the interference.

If this still does not solve the problem it means this frequency is not suitable. Adjust the squelch back to its preset level and use the scan function to locate a clear, interference-free channel.

RP-5100M | RP-5016M transmitter module

This unit should be installed in the Master unit as a Repeater Transmitter to perform wireless link with the Slave unit.

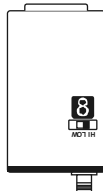
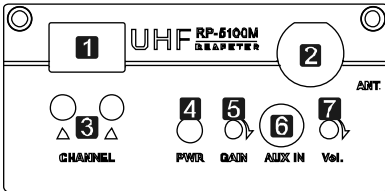

1. Channel indicator
2. Antenna socket (TNC type)
3. Channel selectors
4. Power switch
5. Unit GAIN control
6. 3.5mm audio input socket
7. AUX IN GAIN control
8. Output power switch (on the PCB)

Changing channels

Please select a non-interfering frequency channel to those already used in the master unit receiver modules. For wireless link to work, the channel of the corresponding receiver in the Slave unit should be matched.

RP-5100M (100 channels)

Press LEFT button to increase the TENS-digit channel number.

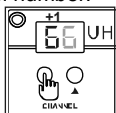

Press RIGHT button to increase the UNIT-digit channel number.

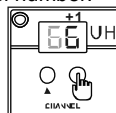

RP-5016M (16 channels)

Press LEFT button to increase the channel number.

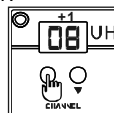

Press RIGHT button to decrease the channel number.

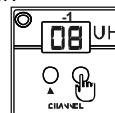

Audio input and gain control

1. Connect your MP3/MP4 player to the AUX IN socket on the panel.

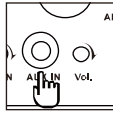

2. Use a mini screw driver to adjust the volume of the input audio.

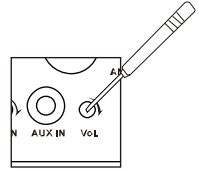

Adjust internal audio gain level

Use a mini screw driver to adjust the volume of audio sources in the master unit.

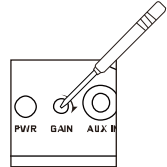

Output power setting

- **LOW** position for low output power and **HI** for high output power.
- Low output power will reduce the RF transmission distance and high output power will extend the possible RF transmission distance.
- If the module is installed on battery-powered amplifiers, remember HIGH output power places slightly more load on the battery and will reduce operating duration faster than LOW output power.

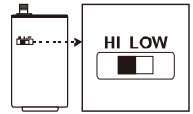

UHF handheld transmitter (SQ-6100 IrDA | SQ-5100 IrDA | SQ-2100 IrDA | SQ-1100 IrDA)

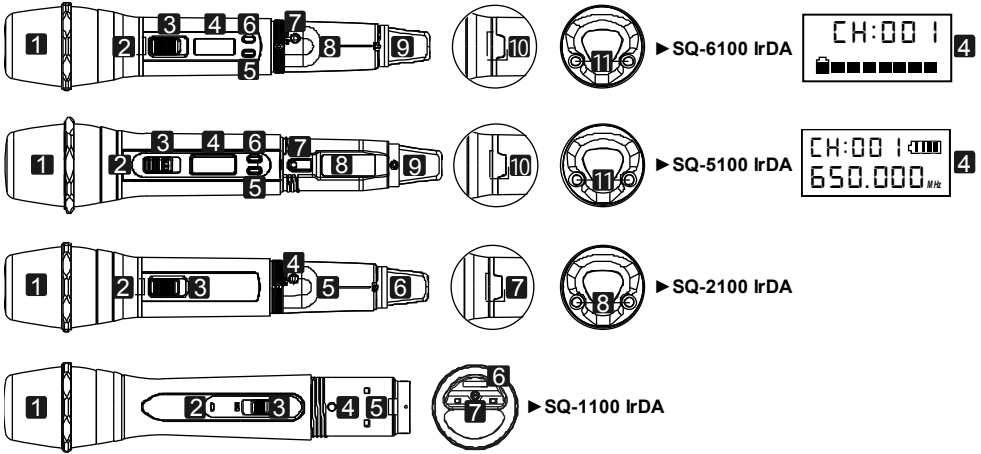

Parts and functions	SQ-6100 IrDA	SQ-5100 IrDA	SQ-2100 IrDA	SQ-1100 IrDA
Cartridge	1	1	1	1
Battery power LED	2	2	2	2
Power switch	3	3	3	3
LCD	4	4	-	-
Menu button	5	5	-	-
Setting button	6	6	-	-
IrDA synchronizing button	7	7	4	4
Battery compartment	8	8	5	5
Color cap	9	9	6	-
IrDA sensor area	10	10	7	6
Charging port	11	11	8	7

3-step power switch (SQ-5100 IrDA)

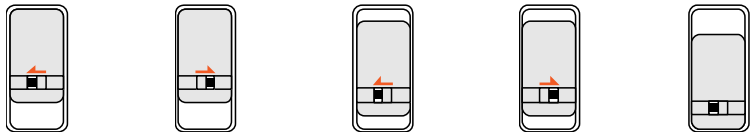

Power status	ON	ON	MUTE	MUTE	OFF
Lock status	unlocked	locked	unlocked	locked	can't be locked

To prevent other user from turning off the power, you may slide this switch to the right to lock the transmitter on stand-by or mute status. Slide to the left to unlock.

Battery installation & indicator

This transmitter requires 2 x AA batteries to operate.

To install, remove the battery cover and slide the batteries into the battery compartment & replace the battery cover.

Note: Batteries contain a corrosive acid that may leak and damage the transmitter when stored for a long period. Batteries should be removed from the transmitter before storing without use for more than 4 weeks.

When the transmitter is switched ON, a blue LED ② will blink once to denote the batteries installed are in good condition. **If the LED remains illuminated, it means the batteries are weak and require replacement.**

Channel synchronizing of the receiver and transmitter

Align infrared areas of the receiver and transmitter within 30cm.

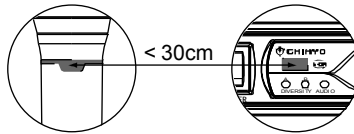

A. Changing the receiver's channel

1. Press the synchronizing button of the transmitter.

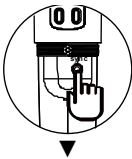

2. The transmitter's LED will glow to denote transmitting the frequency to the receiver and synchronizing the channels.



B. Changing the transmitter's channel

1. Press the synchronizing button of the receiver and the receiver will transmit the frequency to the transmitter and synchronize the channels



2. The transmitter's LED will glow to denote its channel synchronized by the receiver.

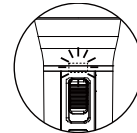

If it doesn't work check that you have the IR sensor panels aligned, that they are facing each other, devices are within 30cm of each other, and try again.

Channel setting (SQ-6100 IrDA | SQ-5100 IrDA)

1. Use **MENU** button⑤ to go to the CHANNEL | FREQUENCY page.

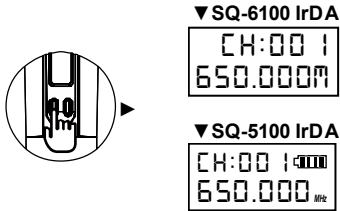

2. Press and hold the **SET** button⑥ for 3 seconds, then

SQ-6100 IrDA: the upper-right channel number will flash to allow changes to be made.

SQ-5100 IrDA: the upper-left letters “CH:” will flash to allow changes to be made.

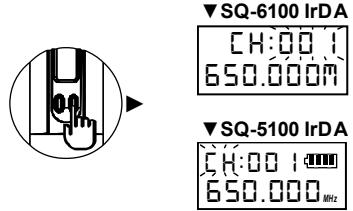

3. Press **SET / MENU** buttons to change the channel number. The corresponding frequency will change accordingly.

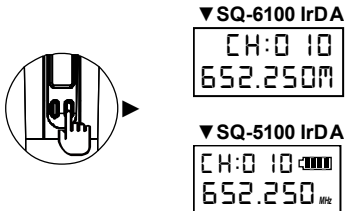

4. 3 seconds after selecting a channel, it will be automatically saved.

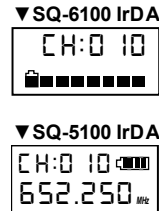

Battery type setting (SQ-6100 IrDA | SQ-5100 IrDA)

1. Use **MENU** button⑤ to go to the BATTERY TYPE page.

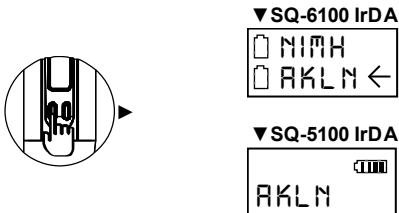

2. Press and hold **SET** button⑥ for 3 seconds, then

SQ-6100 IrDA: the cursor ← will flash to allow changes to be made.

SQ-5100 IrDA: the upper-right battery icon will flash to allow changes to be made.

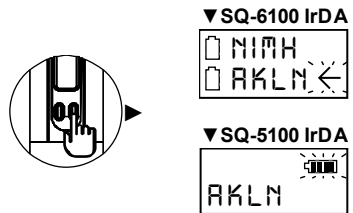

3. Press **SET** button to select either NiMH (rechargeable battery) or AKLN (alkaline battery).

4. 3 seconds after selecting a battery type, it will be automatically saved.

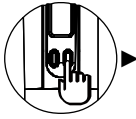

NIMH ←
AKLN

▲SQ-6100 IrDA

NIMH

▲SQ-5100 IrDA

NIMH

Important: NiMH battery must be selected when rechargeable battery is being used. Never select AKLN (alkaline) when transmitter is intended for charging as alkaline battery isn't rechargeable. Wrong battery selection will result in battery sensing electronics to display wrong and misleading status information.

Gain setting (SQ-5100 IrDA)

This transmitter has an RF GAIN sensitivity switch. For close mouth singing or normal speech, please select a lower level (L:01 or L:02). For tripod-mount speech, please select a higher level (L:03 or L:04).

1. Use **MENU** button⑤ to go to the RF GAIN page.
2. Press and hold **SET** button⑥ for 3 seconds, the upper-left letters "L:" will flash to allow changes to be made.



L:01
RFGAIN

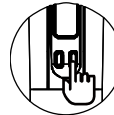

L:01
RFGAIN

3. Press **SET / MENU** buttons to change the gain level between L:01 and L:04.
4. 3 seconds after selecting a gain level, it will be automatically saved.



L:04
RFGAIN

L:04
RFGAIN

UHF belt-pack transmitter (SM-7100 IrDA | SM-6100 IrDA | SM-2100 IrDA | SM-1100 IrDA)

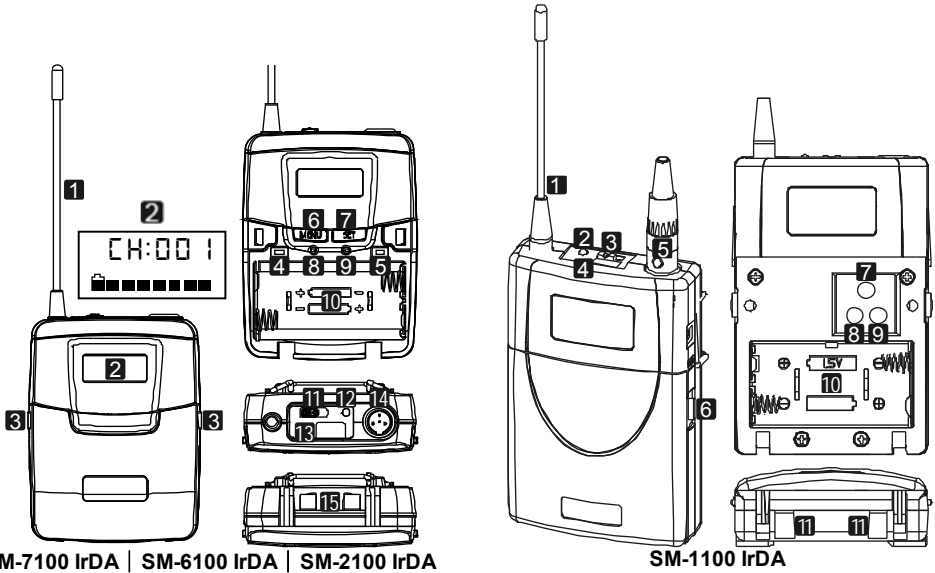

SM-7100 IrDA | SM-6100 IrDA | SM-2100 IrDA

SM-1100 IrDA

Parts and functions	SM-7100 IrDA	SM-6100 IrDA	SM-2100 IrDA	SM-1100 IrDA
Antenna	1	1	1	1
LCD	2	2	-	-
Cover release button	3	3	3	6
Power switch	4	11	11	3
IrDA synchronizing button	5	5	5	7
Menu button	6	6	-	-
Setting button	7	7	-	-
High-impedance gain control (GT)	8	8	8	8
Low-impedance gain control (MT)	9	9	9	9
Battery compartment	10	10	10	10
Audio mute switch	11	-	-	-
Battery power LED	12	12	12	2
IrDA sensor area	13	13	13	4
Audio input connector	14	14	14	5
Charging contacts	15	15	15	11

Battery installation & indicator

This belt-pack requires 2 x AA batteries to operate.

To install, open the battery cover using the cover release buttons and insert the batteries into the battery compartment.

Note: Batteries contain a corrosive acid that may leak and damage the belt-pack when stored for a long period. Batteries should be removed from the belt-pack before storing without use for more than 4 weeks.

When the transmitter is switched ON, the battery power LED (red) will blink once to denote the batteries installed are in good condition. **If the LED remains illuminated the batteries have expired and require replacement.**

GAIN setting (GT | MT)

Gain control enables the user to set different output levels.

GT ⑧ is for the use of instrument with high impedance, such as guitar.

MT ⑨ is for the use of low impedance such as lapel or headset microphones.

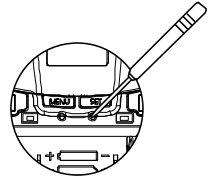

Channel synchronizing of the receiver and transmitter

Align infrared areas of the receiver and transmitter within 30cm.

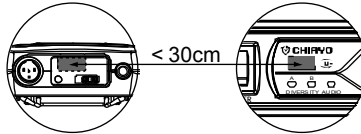

A. Changing the receiver's channel

1. Press the synchronizing button of the transmitter.

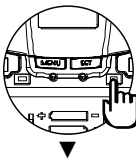

2. The transmitter's LED will glow to denote transmitting the frequency to the receiver and synchronizing the channels.

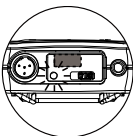

B. Changing the transmitter's channel

1. Press the synchronizing button of the receiver and the receiver will transmit the frequency to the transmitter and synchronize the channels.



2. The transmitter's LED will glow to denote its channel synchronized by the receiver.

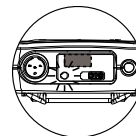

If it doesn't work check that you have the IR sensor panels aligned, that they are facing each other, devices are within 30cm of each other, and try again.

Channel setting (SM-7100 IrDA | SM-6100 IrDA)

1. Use **MENU** button⑥ to go to the CHANNEL | FREQUENCY page.

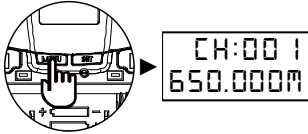

2. Press and hold the **SET** button⑦ for 3 seconds, then the upper-right channel number will flash to allow changes to be made.

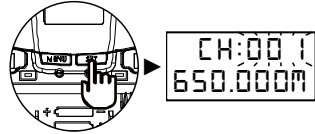

3. Press **SET / MENU** buttons to change the channel number. The corresponding frequency will change accordingly.

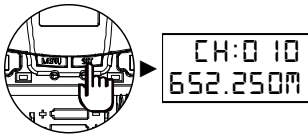

4. 3 seconds after selecting a channel, it will be automatically saved.



Battery type setting (SM-7100 IrDA | SM-6100 IrDA)

1. Use **MENU** button⑥ to go to the BATTERY TYPE page.

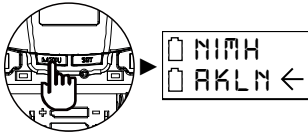

2. Press and hold the **SET** button⑦ for 3 seconds, then the cursor ← will flash to allow changes to be made.

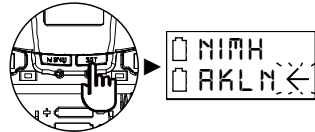

3. Press **SET** button to select either NiMH (rechargeable battery) or AKLN (alkaline battery).

4. 3 seconds after selecting a battery type, it will be automatically saved.

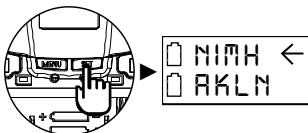

Important: NiMH battery must be selected when rechargeable battery is being used. Never select AKLN (alkaline) when transmitter is intended for charging as alkaline battery isn't rechargeable. Wrong battery selection will result in battery sensing electronics to display wrong and misleading status information.

UHF handheld transmitters (SQ-5016 | SQ-1016V | SQ-1016)

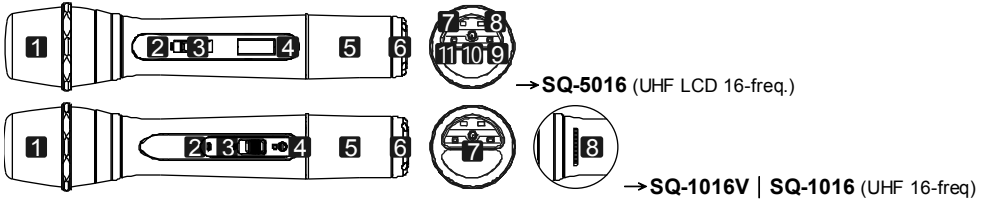

Transmitter parts and functions	SQ-5016	SQ-1016V	SQ-1016
Cartridge	1	1	1
Battery weak/power LED	2	2	2
Power switch	3	3	3
Channel switch	-	4	4
Volume control	-	8	-
LCD	4	-	-
Battery compartment	5	5	5
Bottom cap	6	6	6
Locking button	7	-	-
Setting button	8	-	-
Up button	9	-	-
Charging port	10	7	7
Down button	11	-	-

Battery installation & indicator

This transmitter requires 2 x AA batteries to operate.

To install, remove the battery cover and slide the batteries into the battery compartment & replace the battery cover.

Note: Batteries contain a corrosive acid that may leak and damage the transmitter when stored for a long period. Batteries should be removed from the transmitter before storing without use for more than 4 weeks.

When the transmitter is switched ON, a red LED^② will blink once to indicate the batteries installed are in good condition. **If the LED remains illuminated the batteries have expired and require replacement.**

CHANNEL setting (SQ-1016V | 1016)

Please use the attached small screw driver to set the channel^④.

VOLUME adjusting (SQ-1016V)

Please slide the wheel^⑧ to adjust the volume.

Other settings (SQ-5016)

1. Channel setting



Use UP^⑨ or DOWN[Ⓜ] button to go to the CHANNEL | FREQUENCY page.

After pressing the SET button^⑧ for 3 seconds, the cursor will flash to allow changes to be made. Press UP or DOWN button to change the channel number. The corresponding frequency will change accordingly. When a desired channel is selected, it will be automatically saved and stored in the memory.

2. Battery type setting

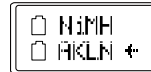

Use UP^⑨ or DOWN[Ⓜ] button to go to the Battery selection page.

After pressing the SET button^⑧ for 3 seconds, the cursor will flash to allow changes to be made. Press UP or DOWN button to move the cursor to either NiMH (rechargeable battery) or AKLN (Alkaline battery) position.

When a battery type has been selected, it will be automatically saved and stored in the memory.

Remark: NiMH battery must be selected when rechargeable battery is being used. Never select AKLN (alkaline) when transmitter is intended for charging as alkaline battery isn't rechargeable. Wrong battery selection will result in battery sensing electronics to display wrong and misleading status information.

3. Sensitivity level setting



Use UP^⑨ or DOWN[Ⓜ] button to go to the SENS SET page.

After pressing the SET button^⑧ for 3 seconds, the cursor will flash to allow changes to be made. Press UP or DOWN button to change the Sensitivity Level of the transmitter.

The MAX level is 4 and the MIN level is 1. When a desired sensitivity level has been selected for your application, it will be automatically saved and stored in the Memory.

Remark: When selecting Sensitivity level, please bear in mind that Level 1 is for close proximity singing purposes whereas Level 4 is for use of transmitter on tripod mount for speech purposes. When Level 4 setting is used for close proximity singing, high SPL input will result in undesirable distortion in the output.

After performing setting changes, you could turn the protective cover 180° in either direction to block the buttons from being accidentally adjusted.

UHF belt-pack transmitters (SM-5016 | SM-2016 | SM-1016)

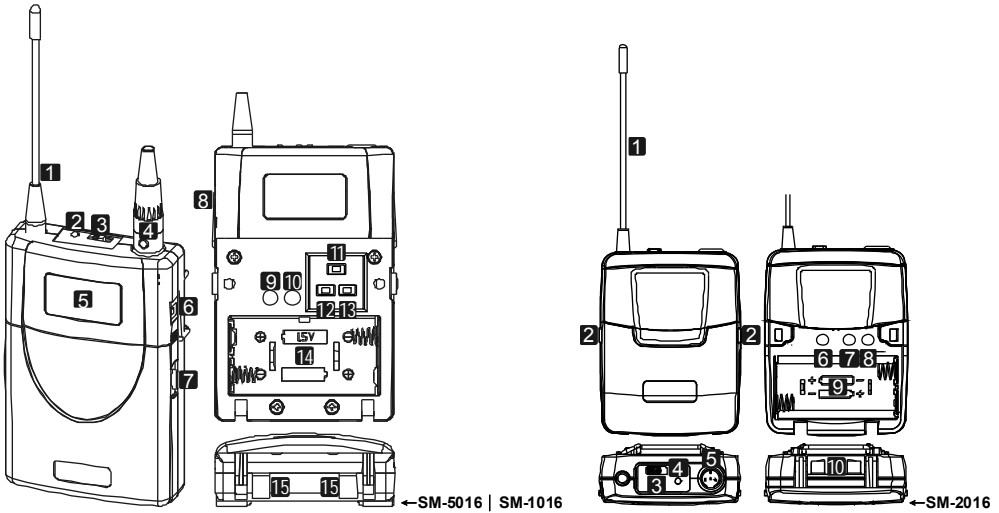

Transmitter parts and functions	SM-5016	SM-1016	SM-2016
Antenna	1	1	1
Battery weak/audio mute indicator	2	2	4
Audio mute switch	3	-	-
Audio input connector (mini XLR)	4	4	5
LCD	5	-	-
Charging port	6	-	-
Cover release button	7	7	2
Power switch	8	3	3
Gain control (GT, high impedance)	9	12	6
Gain control (MT, low impedance)	10	13	7
Setting button	11	-	-
Up button	12	-	-
Down button	13	-	-
Battery compartment	14	14	9
Charging contacts	15	15	10
Channel switch	-	11	8

DPRB-600M MP3 recorder player Bluetooth module

Bluetooth receiver section (LEFT)



- 1. Power/volume control
- 2. LINK button
- 3. LOCK LED
- 4. SCAN LED

Linking instruction

1. Turn on the Bluetooth receiver and both SCAN and LOCK LEDs will flash alternatively.
2. Activate Bluetooth on your device and search new external Bluetooth device named "Bluetooth Speaker".

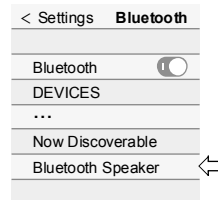
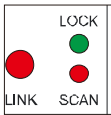

3. Once the linking is finished, the LOCK LED will flash green.
4. Pressing LINK button can cut the connection.

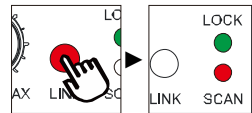
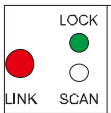



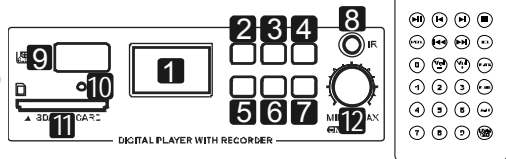























Digital recorder player section (RIGHT)



1. LCD display
2. Press to return to previous track, press and hold to fast reverse.
3. Press to play/pause or stop recording. (readable formats: **mp3**, **wav** and **wma**)
4. Press to go to next track, press and hold to fast forward.
5. Press to record.
6. Press to switch repeat modes.
7. Press to stop playing or recording.
8. IR sensor area
9. USB input
10. USB/SD indicator: The LED flashes green during playing and red during recording. It lights red if there is no track to play, lighting green when playing or recording stops.
11. SD card input
12. Power switch/volume control

Operating functions on the panel and the remote

Operating function	On the panel	On the remote
Play/pause	Press 	Press 
Record	Press  to record and  or  to stop.	Press  to record and  or  to stop.
Skip forward	Press 	Press 
Fast forward	Press and hold 	Press and hold 
Skip backward	Press 	Press 
Fast backward	Press and hold 	Press and hold 
Next folder	-	Press 
Previous folder	-	Press 
Track select (button #0-9)	-	input track number, then press 
USB/SD switch	-	Press 
Repeat mode switch (ALL/SINGLE/FOLDER)	Press 	Press 
Volume control	-	Press  or 
A-B section play	-	Press  to start, again to play section and again to stop
Delete tracks	-	Press  to delete track and again to confirm your delete
Mute	-	press  to mute/recover

Note:

- Supports FAT and FAT32 file systems only.
- Supports MP3, WAV and WMA music formats only
- Record track format :MP3; Bit rate: 128kbps; Sampling frequency: 44kHz
- Recordable only when USB/SD is detected.
- Record files will be stored in the RECORD folder of USB/SD.
- The files will be named as FILE_001, FILE_002, FILE_003...etc.
- The name of a deleted track won't be applied to its next one.
- Recordable until FILE_999 appears with LCD displaying Num Full.
- LCD displays USB FULL or SD FULL when insufficient memory left.
- LCD displays SD LOK if the SD is locked.
- Don't remove the USB/SD during the recording process in case the interrupted track might be damaged.

Operating the CD player

Parts and functions

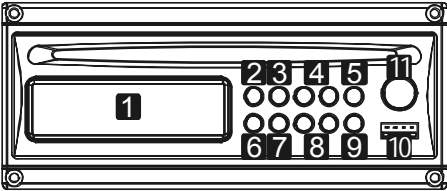

- | | | |
|-----------------|--------------------|---------------------------|
| 1. LCD display | 5. Eject | 9. Infrared receiving LED |
| 2. Play/pause | 6. CD/USB selector | 10. USB input |
| 3. Stop | 7. Repeat | 11. Power/volume control |
| 4. Rev-Skip-Cue | 8. Folder skip | |

Keys	Functions	Panel	Remote
PLAY/PAUSE	When this key is pushed during CD stop, play will start after track search. When this key is pushed during CD is playing, it will be changed to pause. When this key is pushed during CD is pausing, it will be changed to play.	V	V
STOP	When CD is not stop, if this key is pushed then CD will stop.	V	V
FUNC	When press this key will change between CD and USB mode.	V	V
UP/CUE	In stop mode: Change the starting play track (file) during stop mode, cyclic to the first track, if it is in the last track. In program entry mode: Change to the next track(file) for program select . In play mode, pause mode, program play mode, random play mode: Single pressed, skip the playing track (file) to next track (file) for normal play/pause mode, to next program index track(file) for program play/pause mode, to next random track(file) for random play /pause mode. Continue pressed, fast forward during play/pause when pressed more than 0.7sec.	V	V
DONW/REV	In stop mode: Change the starting play track (file) during stop mode, cyclic to the last track, if it is in the first track. In program Entry mode: Change to the previous track (file) for program select. In play mode, pause mode, program play mode: Single pressed, skip the playing track (file) to precious track (file) for normal play/pause mode, to previous program index track (file) for program play/pause mode. Continue pressed, fast reverse during play/pause when pressed more than 0.7sec.	V	V

FOLDER-UP	In stop mode: Skip the starting play folder to next folder during stop mode, cyclic to the first folder if it is in the last folder. In program entry mode: Change the file for program select to next folder's first file, cyclic to the first folder if it is in the last folder. In normal play mode: Skip the playing file to the next folder's first file.	V	V
FOLDER-DOWN	In stop mode: Skip the starting play folder to previous folder during stop mode, cyclic to the last folder if it is in the first folder. In program entry mode: Change the file for program select to previous folder's first file, cyclic to the last folder if it is in the first folder. In normal play mode: Skip the playing file to the previous folder's first file.	V	V
REPEAT	In mp3 mode and in USB mode . If this key is pushed, PLAY mode is changed cyclically shown below. PLAY ALL RANDOM→REPEAT TRACK→REPEAT FOLDER→REPEAT ALL→RANDOM REPEAT→PLAY ALL IN CD mode If this key is pushed, PLAY mode is changed cyclically shown below. PLAY ALL RANDOM→REPEAT TRACK→REPEAT ALL→RANDOM REPEAT→PLAY ALL.		V
EJECT	When this key is pushed, door is moved out.	V	V
PROG	Set to programming mode. When programming mode, "stop" key is pushed then program is all cleared.		V
MUTE	When this key is pushed during CD is playing, the set will mute the output. Pushing again can recovery the output.		V
POWER	Power SW of the set.	V	V
ESP	In CDDA mode, Press "ESP" key, The ESP display lighted and the set is in electronic anti-shock state. The electronic anti-shock time is about 40 seconds. Press "ESP" key again, cancel the ESP function.		V
ID3	When this key is pressed , the "ID3" in the LCD display will flash, and the ID3 TAG is displayed pressing this key again will cancel the ID3 function		V
0~10	You can use these keys to select the track you want directly.		V
VOL.-	When this key is pushed, the volume will decrease by 1dB per step, the min. volume is 0dB.	V	V
VOL.+	When this key is pushed, the volume will increase by 1dB per step, the max. volume is 30dB.	V	V

Caution: This player does not accept 8-cm diameter CD. User is advised to have the USB 2.0 formatted in "FAT" or "FAT 32". The built-in USB 2.0 player can not be able to read the MP3 files stored in your USB if it is not formatted by either "FAT" or "FAT-32". To avoid damage to the USB, remember to detach it only after switching off the player.

Operating the DVD player

Parts and functions

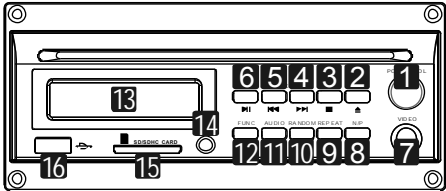

- | | | |
|-------------------------|---------------------|-------------------|
| 1. Power/volume control | 7. Video output | 13. LCD display |
| 2. Eject | 8. N/P | 14. IR LED |
| 3. Stop | 9. Repeat | 15. SD card input |
| 4. Skip/forward | 10. Random | 16. USB 2.0 input |
| 5. Skip/reverse | 11. Audio | |
| 6. Play/pause | 12. Function switch | |

Keys	Function	Panel	Remote
PLAY/PAUSE	Press this key to change between PLAY and PAUSE modes.	√	√
STOP ■/)	When this key is pressed during playing, the set is changed to stop. The stop point is memorized. Then pressing PLAY/PAUSE key, the set will play from the stop point. When this key is pressed twice during playing. The set is changed to stop, then pressing PLAY/PAUSE key, the set will play from the beginning.	√	√
FUNC	When this key is pressed, mode is changed between disk, USB and CARD. CD/DVD→USB→CARD→CD/DVD→...	√	√
N/P	Press the key to change the TV system in the following sequence: PAL→AUTO→NTSC→PAL→...	√	√
EJECT ▲	Press this key, the disk will move out. If the disk is not taken away, press this key again, the disk will slot in.	√	
REPEAT	The default is REPEAT ALL IN MP3 WMA state ,the repeat sequence is as following: REPEAT 1→REPEAT DIR→REPEAT ALL→REPEAT OFF→REPEAT 1→... In CD playing state , the repeat sequence is as following: REPEAT 1→REPEAT ALL→REPEAT OFF→REPEAT 1→...	√	√
POWER	Power switch of the set.	√	√
AUDIO	In play state, press "AUDIO" key can choose different audio channels in the DVD disc.	√	√
REV-SKIP-CUE	Press one of these keys to skip to the next track, long press one of these keys will search forward or backward. X2 X4 X8 X16 and normal PLAY.	√	√
RANDOM	When this key is pressed, it will become random play mode.	√	√
MUTE	When this key is pressed during disc is playing, the set will mute the audio output. Press again to recover the output.		√
VOL.-	When this key is pressed, the volume will decrease by 1dB per step, the minimum volume is 0dB.		√
VOL.+	When this key is pressed, the volume will increase by 1dB per step, the maximum volume is 31dB.		√
0~9;10+	You can use these keys to select the track you want directly.		√

<p>PROG</p>	<p>After programming, the player will play the title, chapter or songs follow the programmed order. Press PROG button ,the menu will display on the screen as following:</p> <div style="border: 1px solid black; padding: 5px; margin: 10px 0;"> <p>PROGRAM</p> <p>T</p> <p>1--:-- play</p> <p>2--:--</p> <p>3--:-- clear</p> </div> <p>In the picture T means TITLE, C means CHAPTER. The divided unit of DVD disc is title, and can divide the title for several chapters. Usually one movie has one title. Some disc are not divided in this way, please pay attention to it when operate GOTO" and "PROG" function. Input relevant title, chapter that you want with the arrows and number keys. Use ↑↓←→ to move the cursor to "PLAY" in the picture above, then press "ENTER" button .the player will start playing follow the programmed order. Also use the same way to move the cursor to "CLEAR" and press "ENTER" button can clean the programmed order. Press "PROG" key again will exit the program mode.</p>		<p>V</p>
<p>GOTO</p>	<p>Press GOTO to reach the title, chapter or time you want.</p>		<p>V</p>
<p>OSD</p>	<p>In play state, press OSD key, the play information of the disc will show on the screen. Press it again, the OSD information will disappear.</p>		<p>V</p>
<p>PBC</p>	<p>The key only act for VCD disc.</p>		<p>V</p>
<p>ZOOM</p>	<p>In play state, press "ZOOM" key ,the display screen will zoom by 1X, 2X, 3X and normal play.</p>		<p>V</p>
<p>SLOW</p>	<p>Press "SLOW" key ,the set will become slow motion as following cycle: 1/2→1/4→1/6→normal→1/2→...</p>		<p>V</p>
<p>↑↓←→ ENTER</p>	<p>Cursor move keys and confirm keys.</p>		<p>V</p>
<p>ANGLE</p>	<p>Press "ANGLE" to choose different angles of the disc that recorded with multi-angle. It doesn't work if the DVD disc doesn't support multi-angle.</p>		<p>V</p>
<p>SUB-T</p>	<p>In play state press "SUB-T" button to choose the different subtitles in the DVD disc.</p>		<p>V</p>
<p>SETUP</p>	<p>Press "SETUP" key to enter setup manual.</p>		<p>V</p>
<p>TITLE</p>	<p>Press "TITLE" key the screen will show title and manual for selection.</p>		<p>V</p>

Maintenance-free Lead Acid battery

Guidelines for maintenance-free Batteries:

1. Battery should operate at temperatures between 15°C ~ 50°C. To ensure a longer life span, it should be kept between 5°C ~ 35°C. For optimum result, 20°C ~ 25°C will be ideal. When temperature falls 15 degrees below zero, battery will undergo some changes in its chemical contents and therefore cannot be recharged. Operating the battery at higher temperature will result in higher capacity but shorter lifespan, whereas lower temperatures operation has a longer lifespan but less capacity.
- 2. If the battery is not recharged 72 hrs after it is completely used, it will be permanently damaged.**
3. When the battery is being charged, the internal gases will be electrolyzed into water at the negative charge, maintaining the battery's storage abilities with no water added. However, erosion at the charged ends of the battery will cause poor performance.
4. The battery's cycle lifespan (no. of charge and discharge cycle) is determined by the degree at which power is dissipated, especially the degree of discharged each time it is used and the recovery charging method. For normal use, the battery can be used for longer hours when less power is dissipated each time and vice versa. At 25°C, maintenance-free batteries could be charged 150 ~ 200 times at 100% discharge each time.
5. Decrease in capacity, internal short circuit, deformation in appearance, erosion of charged ends and decrease in open circuit voltage are symbols indicating battery is approaching the end of its life cycle.
6. When two batteries are used in parallel connection, the resistance of the cables should be kept equal.

Properties of the Lead Acid Battery:

1. Has no memory effect. Can be charged anytime, even when the recharge indication light is off.
2. Performance and efficiency are affected by changes in the environment, especially temperature and humidity. (Best operated between 20°C ~ 25°C)
- 3. Battery discharge naturally according to a certain pattern even not in use. For best performance and a prolonged lifespan, it should be recharged every month even when not in use.**
4. Under normal circumstances, battery could last for about a year.
5. When the battery's life expires, possible indicators include internal short-circuit, decrease in capacity, deformation in appearance, erosion of charged ends and decrease in operating voltage.

User's Precautions:

- 1. For first-time use, charge the battery for 10 hrs until it is fully charged.**
2. To maintain performance and lifespan, if product has not been used for 3 months after the initial shipment, please fully charge the battery.
- 3. Before each use, it's advisable to charge the battery to its full capacity.**
4. The average lifespan of the battery is one year. The user is advised to change the battery after one year of use.
5. The current consumption is in direct ratio with load current. The more current consumption, the less the operation time.
- 6. Warranty will be void if the battery is not charged for a prolong period as it may lose all its charge and could never be recovered again.**

FCC Caution

To assure continued compliance, any changes or modifications not expressly approved by the party responsible for compliance could avoid the user's authority to operate this equipment. (Example - use only shielded interface cables when connecting to computer or peripheral devices.

This device complies with Part 15 of the FCC Rules and RSS-123 of Canada. Operation is subject to the following two conditions:

- (1) This device may not cause harmful interference, and
- (2) this device must accept any interference received, including interference that may cause undesired operation.

CHIAYO

CHIAYO ELECTRONICS CO.,LTD.

[Http://www.chiayo.com.tw](http://www.chiayo.com.tw) | Email: sales@chiayo.com.tw

Office: 30, Lane 27, Section 4, Jen-Ai Road, Taipei 10685, Taiwan | Tel: 886-2-27415741 | Fax: 886-2-27525242

Factory: 88, Chung-Hsiao Street 2, Chiayi 60080, Taiwan | Tel: 886-5-2711000 | Fax: 886-5-5767611